

Perspective View

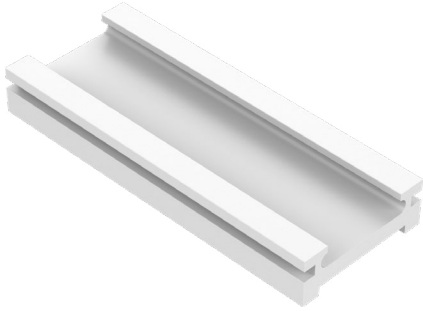

Assembled End Views

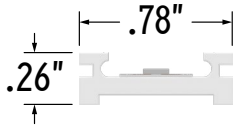

DRY LOCATION

1. Measure area where luminaire will be installed. Use a laser line to create a reference line along installation area, ensuring consistent alignment of mounting channels. Mark location where mounting channels will be installed along reference line.
2. Lay extrusions along chalk line and drill at least 3 countersink holes per extrusion. Drill additional holes as needed.

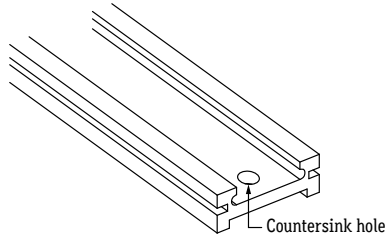

3. Screw extrusions to surface using countersink screws.
Note: Ensure extrusions are aligned. Misalignment will prevent lens from snapping in.

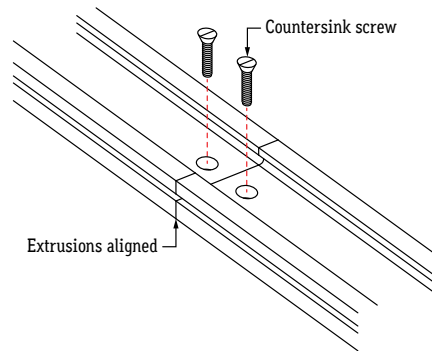

4. After all extrusions have been securely mounted, remove adhesive backing from lightstrip and stick in place along extrusion channel, ensuring lightstrip is secure inside extrusion.

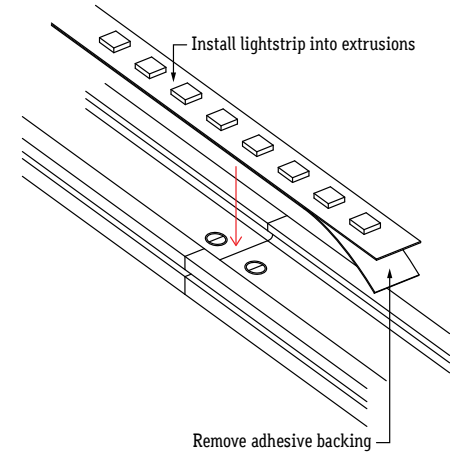

5. Ensure lightstrip is secured in place and is free of twists, tangles, creases, or bumps.

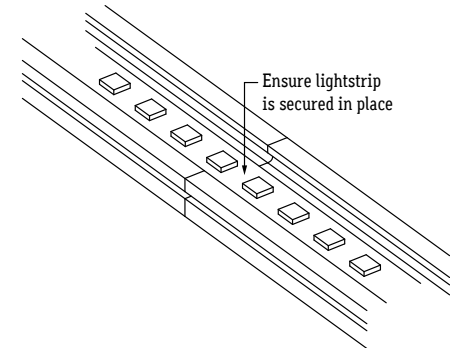

6. If applicable, connect disconnects between luminaires or solder connectors.

7. Perform continuity test before connecting luminaire to power source.

Perspective View

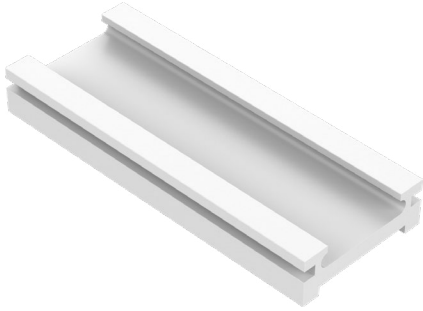

Assembled End Views

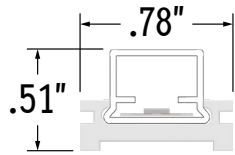

WET LOCATION

1. Measure area where luminaire will be installed. Use a laser line to create a reference line along installation area, ensuring consistent alignment of mounting channels. Mark location where mounting channels will be installed along reference line.
2. Lay extrusions along chalk line and drill at least 3 countersink holes per extrusion. Drill additional holes as needed.

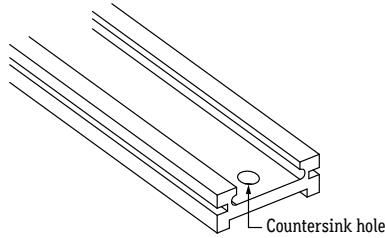

3. Screw extrusions to surface using countersink screws.
Note: Ensure extrusions are aligned. Misalignment will prevent lens from snapping in.

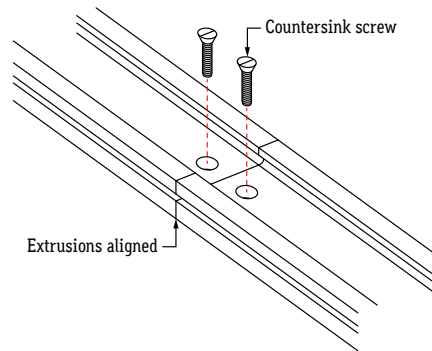

4. Install tube into extrusions, overlapping where two extrusions meet. Plan your cuts so that the tube will always overlap where two extrusions meet. Overlapping tubes helps keep extrusions aligned and prevents light leaks.

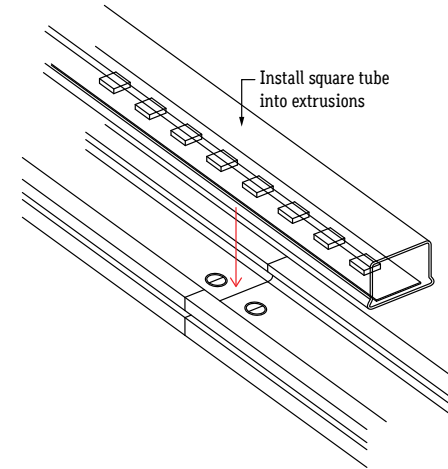

5. Ensure tube is secured in place.

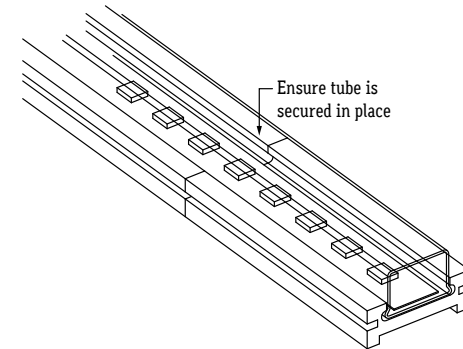

6. If applicable, make connections between luminaires using wet location connectors.
7. Perform a continuity test before connecting luminaire to power source.