

END VIEWS / DIMENSIONS

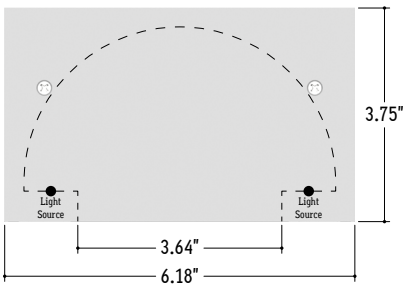

Note: End View dimensions do not include ceiling trims or mounting options. Refer to trim-specific installation instructions for additional details.

GENERAL FEATURES

APPLICATIONS	Indirect Lighting
LENS	Clear
LENGTH	Built to Order (± 0.25" Tolerance)
CONSTRUCTION	Aluminum Extrusion
FINISH	White
WEIGHT	4.80 lbs per foot
MOUNTING	Aircraft Cable
LISTING	Dry or Damp Location UL1598, CSA C22.2#250.0 UL8750, CSA250 UL2108, 67.1.9, 60.4, CSA C22.2 #9
DRIVER	Driver on Board or Remote Driver
CLOSET RATING	Up to 3.6 Watts per Foot Maximum
TEMPERATURE RATINGS	Operating / Startup: -20° to 48°C (-4° to 120°F) Storage: -40° to 76°C (-40° to 170°F)
INSTALLATION LINKS	Flange Ceiling Trim (FG) T-Bar Ceiling Trim (TB) T-Bar Return Ceiling Trim (TBR) Hard Ceiling Trim (HC) Mud-In Ceiling Trim (MI)

MOUNTING OPTIONS

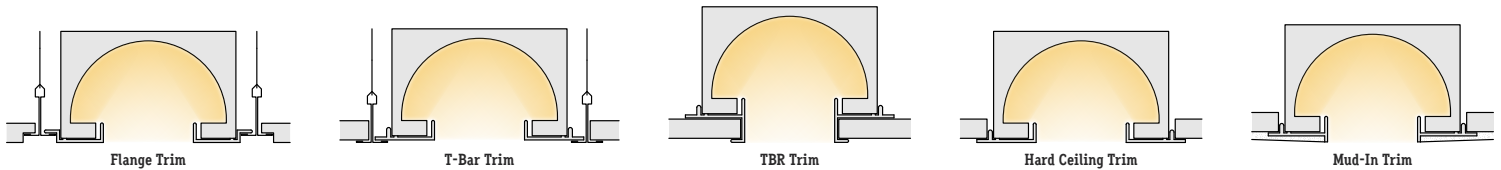

SPECIFY PRODUCT CODE | CHOOSE FROM DROP DOWNS

SERIES	CCT GAMUT		WATTS PER FOOT	CONTROL INTERFACE	LISTING	LUMINAIRE VOLTAGE	LUMINAIRE LENGTH
	LOW CCT	HIGH CCT					
	UNV						
Flange Ceiling Trim (ALS500T-DBR-CT-FG)	2000K (20K) 2200K (22K)	3000K (30K) 3500K (35K)	1.5 Watts x 2 = 3 Watts (3W) 219 Lumens/ft*1 2 Watts x 2 = 4 Watts (4W) 292 Lumens/ft*1	DALI*2 (DALI)	Indoor (DRY)	120 - 277VAC Line Voltage**4 (UNV)	Specify Length in Feet & Inches Example: 7'8"
T-Bar Ceiling Trim (ALS500T-DBR-CT-TB)	2400K (24K) 2700K (27K)	4000K (40K) 4500K (45K)	3 Watts x 2 = 6 Watts (6W) 438 Lumens/ft*1 4 Watts x 2 = 8 Watts (8W) 584 Lumens/ft*1	0-10V: 100% - .1% (10V)	Outdoor (DAMP)		
T-Bar Return Ceiling Trim (ALS500T-DBR-CT-TBR)		5000K (50K) 5500K (55K)	5 Watts x 2 = 10 Watts (10W) 730 Lumens/ft*1 6 Watts x 2 = 12 Watts (12W) 876 Lumens/ft*1	DMX-512*3 (DMX)			
Hard Ceiling Trim (ALS500T-DBR-CT-HC)		6000K (60K) 6500K (65K)	7 Watts x 2 = 14 Watts (14W) 1022 Lumens/ft*1				
Mud-In Ceiling Trim (ALS500T-DBR-CT-MI)							

Note: See page 2 for ordering notes & restrictions.

ORDERING NOTES & RESTRICTIONS

- *¹ Lumens per Foot based on 35K CCT LED. **Example:** 73 Lumens x 3 Watts = 219 Lumens per Foot.
- *² DALI commissioning to be performed by a third party at time of installation. CALI does not provide DALI commissioning.
- *³ Default DMX address of each fixture is 001. Consult third party DMX commissioner to modify at time of installation.
- *⁴ Remote drivers wattage sized based on length of run. **Example:** 10' run x 6 watts per foot = 60 watts. Driver will be sized to 60 watts maximum.

ELECTRICAL

DIMMING	0-10V, DMX, DALI (Type 6)
MAXIMUM RUN	28' (3W), 21' (4W), 14' (6W),
(Class 2 Applications)	10' (8W), 8' (10W), 7' (12W), 6' (14W)
LUMINAIRE VOLTAGE	120V - 277V (UNV)

COMPATIBLE CONTROL INTERFACES

- 0-10V
- Distech Controls
- Crestron / Cresnet / SolarSync
- DALI2
- Legrand
- Eaton
- DMX
- Wattstopper
- Tridonic / Bluetooth
- Acuity Controls / nLight
- Pass & Seymour
- eldoLED
- Leviton

LAMP FEATURES

LAMP TYPE	High Output LEDs (No Mercury)
CRI	> 91
EFFICACY	73 Lumens per Watt (Based on 35K CCT LED) 84 Lumens per Watt (Based on 65K CCT LED)

Note: Lumen per Watt based on highest tested CCT value of each gamut. Refer to Photometry data for additional information.

LAMP SPECIFICATIONS

GAMUT RANGE	DESCRIPTION	L70 LED LIFE
20K-35K	Dynamic White: 2000 Kelvin - 3500 Kelvin	60,000 hrs.
27K-65K	Dynamic White: 2700 Kelvin - 6500 Kelvin	

DRIVERS

DIMMING SELECTION	PRODUCT CODE	LINK TO SPECIFICATION SHEET / URL
DALI	(DALI)	https://www.calilighting.com/assets/pdf/drivers/DRV100-E.pdf
0-10V: 100% - 1%	(10V)	https://www.calilighting.com/assets/pdf/drivers/Drivers-Brochure.pdf
DMX-512	(DMX)	https://www.calilighting.com/assets/pdf/drivers/DRV100-E.pdf

DYNAMIC WHITE CONTROLS (Sold Separately)

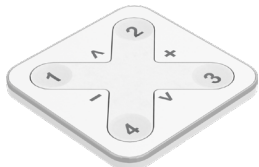

Bluetooth Wireless Control Panel
(CTRL-DWH-BT)

PART #	QTY.
CTRL-DWH-BT	



10V Control Switch
(CTRL-DWH-10V)

PART #	QTY.
CTRL-DWH-10V	



DMX Touch Panel
(CTRL-DWH-DMX)

PART #	QTY.
CTRL-DWH-DMX	



DALI Touch Panel
(CTRL-DWH-DALI)

PART #	QTY.
CTRL-DWH-DALI	

TRIM STYLE

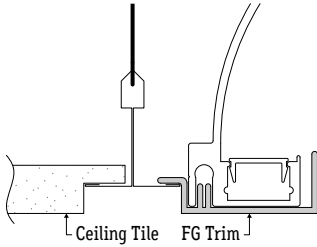

Flange Ceiling Trim
(ALS500T-DBR-FG)

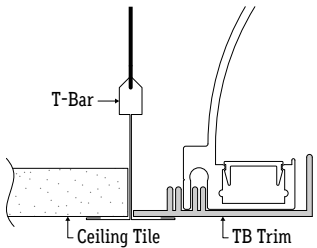

T-Bar Ceiling Trim
(ALS500T-DBR-TB)

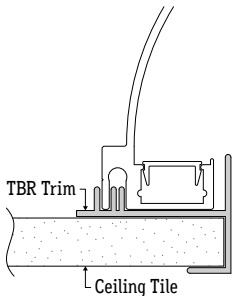

T-Bar Return Ceiling Trim
(ALS500T-DBR-TBR)

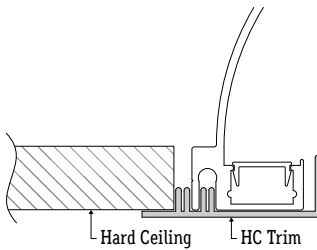

Hard Ceiling Trim
(ALS500T-DBR-HC)

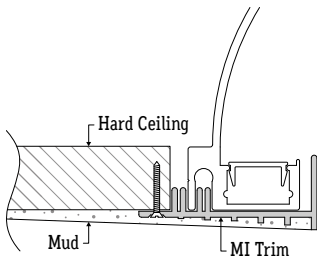

Mud-In Ceiling Trim
(ALS500T-DBR-MI)

DESCRIPTION

- Compatible with T-Bar ceiling grid systems
- Best used with tegular-edged tiles
- Trim rests on T-Bar grid

- Compatible with T-Bar ceiling grid systems
- Best used with square-edged tiles
- Trim rests on T-Bar grid

- Compatible with T-Bar ceiling grid systems
- Luminaire sits centered within the tile and spans a length shorter than the length of the tile.

- Compatible suspended hard ceiling systems
- Best used with drywall ceiling
- Trim is flush with ceiling surface

- Compatible suspended hard ceiling systems
- Best used with drywall ceiling
- Trim uses mud-in finish for seamless appearance

FINISHED APPEARANCE

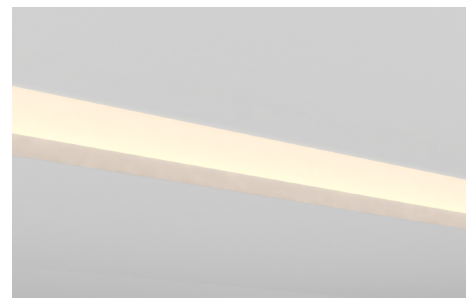
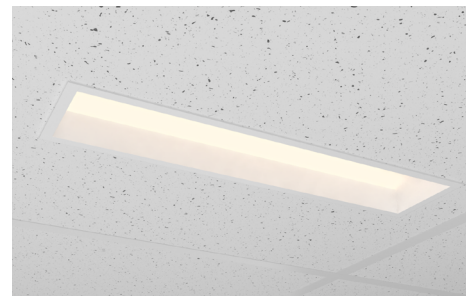
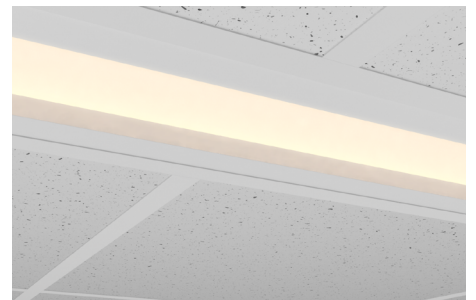
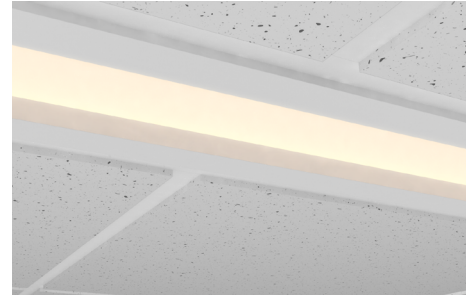

MOUNTING ACCESSORIES (Sold Separately)

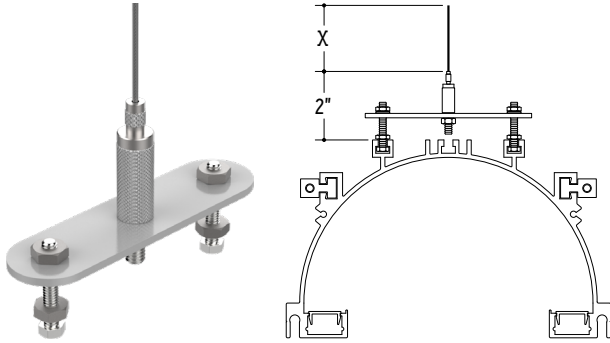

Aircraft Cable Assembly
(ALS500T-DBR-AC-6')

PART #	QTY.
ALS500T-DBR-AC-6'	

Note: Use 3 Aircraft Cable Assemblies per 8', rounded up. Consult factory for custom cable lengths.

ILLUMINATED CORNER (Sold Separately)

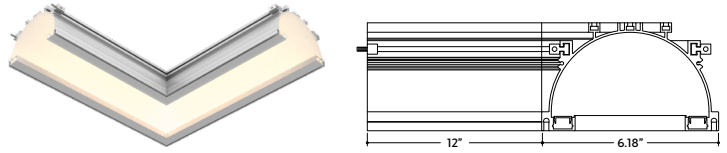

90° Illuminated Corner
(ALS500T-DBR-CT-90D-X) X = Specify Product Code

SERIES	CCT GAMUT		WATTS PER FOOT	CONTROL INTERFACE	LISTING	LUMINAIRE VOLTAGE	QTY.
	LOW CCT	HIGH CCT					
							UNV

Note: Specify product code to match specified code from page 1.

END CAPS & REFLECTIVE FILM (Sold Separately)



Standard End Cap
(ALS500T-DBR-EC)

PART #	QTY.
ALS500T-DBR-EC	

Note: Use 1 Standard End Cap when the run terminates at a flat wall.

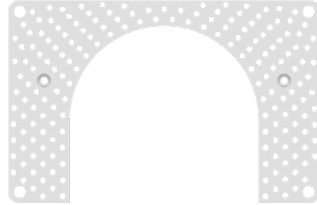

Mud-In End Cap with Round Opening
(ALS500T-DBR-EC-RD)

PART #	QTY.
ALS500T-DBR-EC-RD	

Note: Use 1 Mud-In End Cap when the run will terminate with an opening.

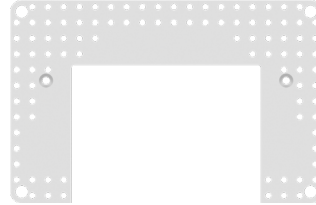

Mud-In End Cap with Square Opening
(ALS500T-DBR-EC-SQ)

PART #	QTY.
ALS500T-DBR-EC-SQ	

Note: Use 1 Mud-In End Cap when the run will terminate with an opening.



Additional Reflective Film
(ALS500T-DBR-RF-X)
X = Specify Length Below

PART #	QTY.
ALS500T-DBR-RF-25'	
ALS500T-DBR-RF-50'	
ALS500T-DBR-RF-75'	
ALS500T-DBR-RF-100'	
ALS500T-DBR-RF-150'	
ALS500T-DBR-RF-200'	
ALS500T-DBR-RF-250'	

Note: Reflective Film is included with each run length. Use this accessory to order additional film if needed.

DESIGN GUIDELINES

Individual Run

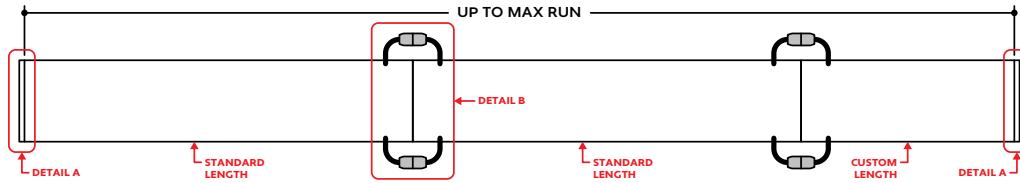

Run with Mitered Corners

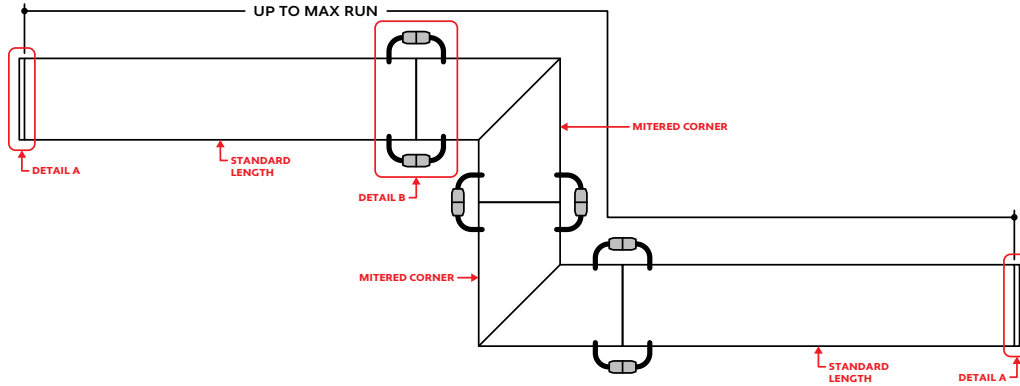

Run with Jumper Cables

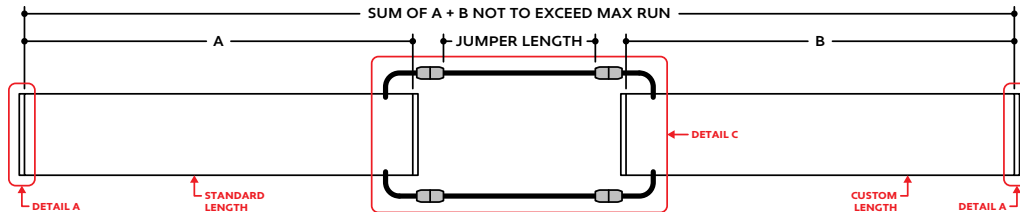

Continuous Run Exceeding Maximum Run (2 Circuits)

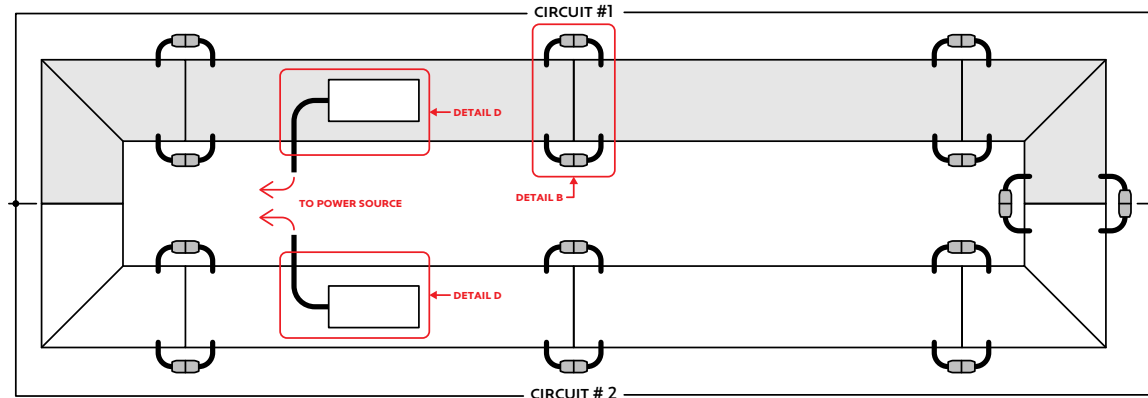

KEY

- DETAIL A** **End Cap:** An end cap is used to terminate each run at either end.
- DETAIL B** **Continuous Connection:** Luminaire segments are connected using an included continuous connector. See installation instructions for details.
- DETAIL C** **Continuous Connector (Jumper):** Used to span a corner or traverse a gap, corner, or obstacle in the installation area.
- DETAIL D** **Remote Driver:** For T-Bar ceiling grid applications, the driver may be mounted on top of the luminaire. See installation instructions for details.

Note: Drawings not to scale. Product may differ from examples shown.

CALIFORNIA ACCENT LIGHTING, INC.

2820 E. Gretta Lane, Anaheim, CA 92806
 ph. 800.921.CALI (2254) | fx. 714.535.7902 | info@calilighting.com | calilighting.com
 © CALI. All rights reserved. CALI reserves the right to make changes or withdraw specifications without prior notice.